



TC350 TURF CUTTER

Operation, Safety & Maintenance Instructions



 **YouTube - HIRE A TURFCUTTER**

Online Demonstration Available at: www.redroo.com/products/turfcutter



INTRODUCTION

Dear Valued Customer,

Congratulations! You have purchased one of the most superbly crafted Turf Cutters in the world. Properly maintained, it will give you years of reliable service. When the instructions in this manual are adhered to, operation is safe and simple.

Red Roo Turf Cutters are built to withstand the most difficult conditions. Designed with simplicity and safety in mind, this Turf Cutter performs using precision engineered componentry and the force of gravity.

The Red Roo Turf Cutter is designed to cut turf with ease and precision. Its heavy duty construction and premium engine provide the durability required for this application.

Thank you for purchasing this Red Roo product and remember to operate it responsibly and safely.

For your future reference

Serial No. _____ **Date of Purchase** _____



TABLE OF CONTENTS

ABOUT THIS MANUAL	4
SAFETY INSTRUCTIONS	5
OPERATING INSTRUCTIONS	6
TC350 DIAGRAM	7
CARING FOR YOUR POWDERCOAT FINISH	8
TC350 ILLUSTRATION	9
TC350 PARTS LIST	10
TC350 PARTS LIST	11
TC350 PARTS LIST	12
TC350 SERVICING HISTORY	13
WARRANTY POLICY	14

RED ROO SALES & SERVICE COMPANY PTY. LTD

41-43 Keysborough Avenue, Keysborough, Victoria, Australia 3173
Tel.: +61 (03) 9769 0455 Fax: +61(03) 9769 0366

Outside Melbourne Metro: Tel.: 1300 133 767 Fax: 1300 133 757

www.redroo.com

ABOUT THIS MANUAL

The information contained in this manual has been prepared to assist you in the safe operation, the routine maintenance and general care of your Red Roo product. By following these guidelines, you may look forward to years of reliable service from your Red Roo. Information is categorised and denoted by the following symbols and phrases:



SAFETY FIRST

Identifies general safety practices.



DANGER!

An instruction which, if not followed, could result in serious or fatal injury



WARNING!

An instruction which, if not followed, could result in personal injury.



CAUTION!

An instruction which, if not followed, could result in the possibility of personal injury or damage to machine components.

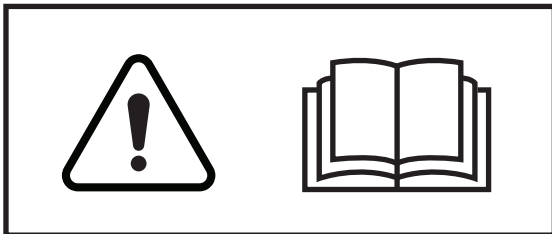

Before operating this Machine read and observe all Warnings, Cautions and Instructions on the Machine and in the Operators Manual. Although the reading of information contained in this manual does not eliminate the risk involved in operating this machine, your understanding of this information will promote the correct and safe use of your machine. Failure to follow Instructions and Safety Information could result in serious injury or death.

HAZARD WARNINGS



Read



Hearing Protection



Eye Protection



Wear Gloves



Cut Hand



Electrical Shock



Moving Parts



Hot Surfaces



Remove Spark Plug Leads



Toxic Fumes



Explosion



Don't Refuel Hot Engine

SAFETY FIRST



Read this section before use!

The TC350 Turf Cutter is designed to cut turf and therefore is potentially dangerous. Careless or improper use may cause serious or even fatal injury.

It is important that you read and understand the contents of both this manual and the engine manual. Allow only mature, adult individuals to operate your turf cutter. **It is your responsibility to ensure that any individual who operates your turf cutter has read and understood these manuals.**

Never use the turf cutter for any other purpose than cutting turf. The machine is designed explicitly for this purpose and this purpose only. Any other use may result in serious or fatal injury and/or damage to the machine.

SAFETY INSTRUCTIONS

- 1)  **DO NOT** allow any person to operate the turf cutter without first reading and understanding the safety and operating instructions.
KNOW THE CONTROLS & HOW TO STOP THE TURFCUTTER QUICKLY IN AN EMERGENCY

- 2) **NEVER** allow **CHILDREN** or **UNTRAINED ADULTS** to operate the turf cutter

- 3) **PPE (PERSONAL PROTECTION EQUIPMENT) IS MANDATORY BEFORE OPERATING THIS MACHINE**
ALWAYS wear protective clothing when operating the turf cutter. This includes, but not limited to; safety glasses, loose fitting gloves, steel capped boots and hearing protection. **NEVER** wear loose fitting clothing or jewelry when operating the turf cutter. Keep all clothing away from moving parts. Clothing could become caught in the machine resulting in injury.



- 4) **ALWAYS** operate the turf cutter in a well-lighted area

- 5) **ALWAYS** make certain that both control clutches are in the “**DISENGAGED**” position prior to starting the engine.

- 6) **ALWAYS** operate the turf cutter on level ground only. Keep your work area clear and free of debris.
DO NOT operate on angle that exceeds 15° degrees.

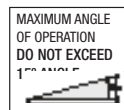

- 7) **NEVER** operate the turf cutter when fatigued. **ALWAYS BE ALERT!** If you get tired while operating the turf cutter take a break. If you have any type of physical or mental condition that may be aggravated by strenuous work, consult with your physician before operating this piece of equipment. **NEVER** operate the turf cutter under the influence of medication, alcohol or drugs.

- 8)  **DO NOT** allow other adults, children or animals near the turf cutter. **IT IS THE RESPONSIBILITY OF THE OPERATOR** to keep bystanders and animals a minimum of 6 metres (18 feet) away from the turf cutter while in operation.

- 9)  **ALWAYS KEEP YOUR HANDS, FEET, AND BODY AWAY FROM TURF CUTTING ZONE WHILE THE ENGINE IS RUNNING**

- 10)  **NEVER** remove the safety guarding attached to the turf cutter. These protective devices must be in place and in good working order at all times during the operation of this machine. Keep the unit well maintained and in good working order.

- 11) **DO NOT** leave the machine unattended while the engine is running.

- 12)  **DO NOT** over speed the engine or alter the governor settings. Excessive speed is dangerous and will shorten engine life.

- 13)  **NEVER OPERATE THE TURF CUTTER IN AN ENCLOSED AREA.**
Engine exhaust contains carbon monoxide, an odourless and tasteless poison that can kill

- 14) **STOP** the engine, disconnect the spark plug leads and allow engine to cool before inspecting or performing maintenance

- 15) **REFUELLING**



- Shut off engine. **DO NOT REFUEL AN ENGINE WHILE OPERATING MACHINE!**
- **ALLOW** engine to cool down. Minimum 5 minutes
- **USE UNLEADED FUEL ONLY**
- **USE CLEAN FRESH UNLEADED FUEL**
- **Do not mix oil with unleaded fuel**
- Do not over-fill fuel tank. Allow space for fuel expansion
- Do not smoke
- Allow no naked flame or hot material in refuelling area
- Use only approved fuel containers and funnels.



REMEMBER FUEL IS A POTENTIAL FIRE HAZARD

OPERATING INSTRUCTIONS

- 1)  Remove the turf cutter from its carrying vehicle or trailer.
ALWAYS USE CAUTION
- 2) Familiarize yourself with this turf cutter and its controls. Learn where all engine controls are and be prepared to stop this machine quickly in a possible emergency.
- 3) **PPE (PERSONAL PROTECTION EQUIPMENT) IS MANDATORY BEFORE OPERATING THIS MACHINE.** Wear safety glasses or helmet and visor combination, loose fitting gloves, hearing protection, and steel caps boots when operating this machine.



- 4) Before starting the engine, ensure the turf cutting blade is in the raised position.
- 5) Before starting the engine, ensure both clutch handles are forward and disengaged.
- 6) Move choke control to Choke or Start position:
NOTE: CHOKE MUST FULLY CLOSE.
MOVE THROTTLE CONTROL TO RUN OR FAST POSITION OPERATE ENGINE AT MAXIMUM RPMs
- 7) Maneuver the turf cutter to the area where the turf is to be removed. This can be done by pushing the turf cutter or driving the machine using its own power, simply engage the wheel drive clutch and move the machine to the desired cutting area.
- 8) When the operator is ready to start cutting turf, lower the turf cutting blade to the desired depth by lifting up on the depth control handle.
- 9) Adjust the throttle lever (located on the engine) to achieve desired rpm (motor speed) according to the conditions **WARNING! KEEP HANDS AND FEET CLEAR OF TURF CUTTING BLADE AT ALL TIMES**
- 10) To start the turf cutting blade slowly push the blade engagement clutch lever towards the engine.
- 11) Only after the turf cutter blade has been lowered and the blade engagement clutch lever has been activated are you ready to engage the wheel drive clutch lever.
- 12) Completely Engage the self propelled wheel drive clutch lever
WARNING! IN CASE OF DIFFICULTY, DISENGAGE BOTH CLUTCH LEVERS (ALL ACTION STOPS)
TURN THE ENGINE SWITCH TO OFF LOCATED ON HANDLE BAR OR ENGINE
- 13) When you are finished cutting the turf, reverse the procedure:
 - a) Reduce the throttle speed
 - b) Disengage self-propelled clutch – pull backwards toward operator
 - c) Disengage turf cutting blade – pull backwards toward operator
 - d) Raise the turf cutting blade
 - e) Engage the self-propelled clutch lever and return to the trailer/carrier
 - f) Use Caution
- 14) **STOP ENGINE:** Do not move the choke control to the **CHOKE** position to stop the engine.
- 15) Move throttle control to the slow position

AFTER USE

- 1) Turn fuel tap to the off position
- 2) Allow the machine to cool down
- 3) Keep the machine clean using warm soapy water. Make sure that no water enters the carburetor
- 4) Remove any weeds, wire, rope, etc. that may have wrapped around the cutting assembly

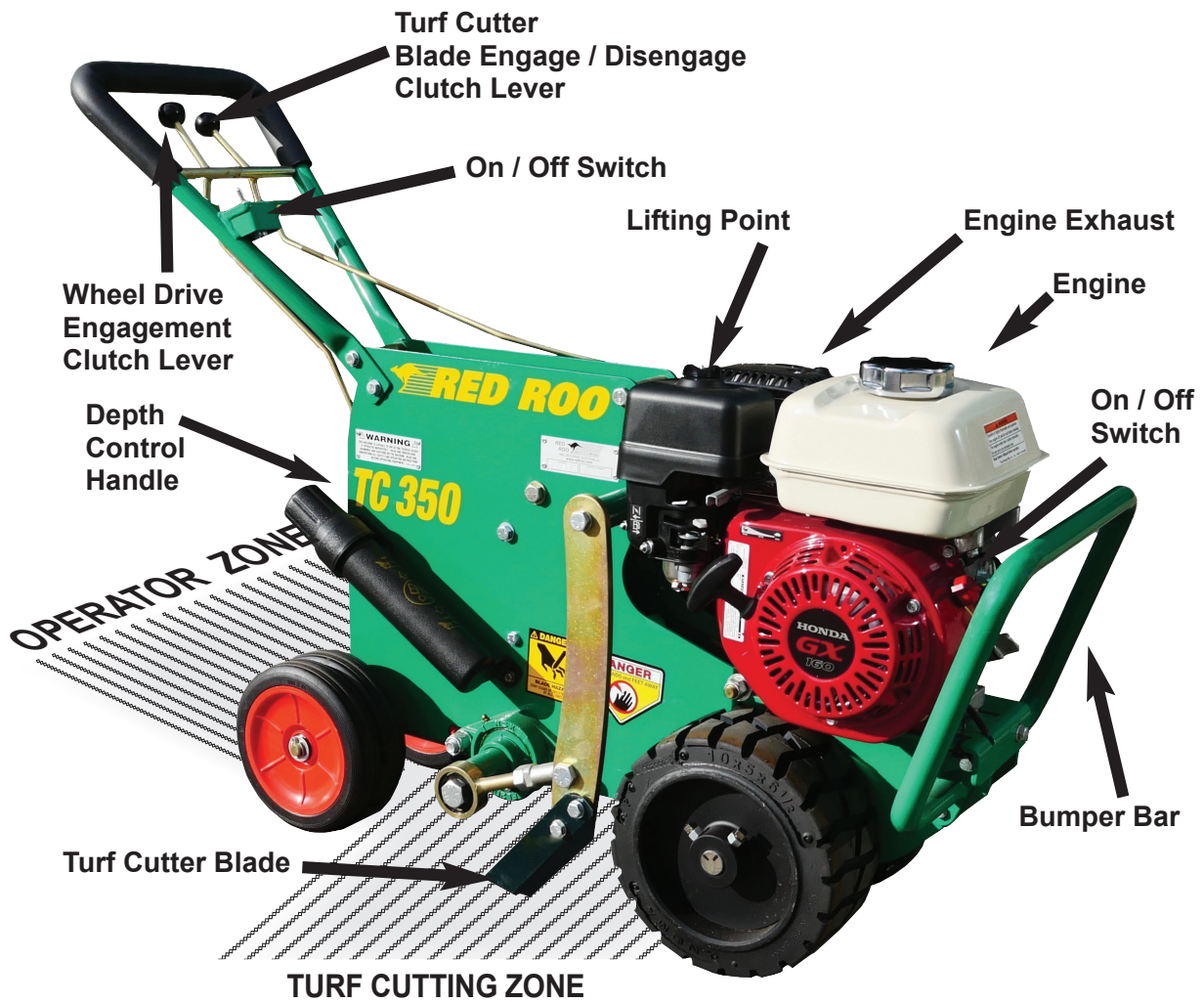

safety
IS EVERYBODY'S BUSINESS
...now

You alone know the operational demands and special conditions affecting the equipment in to your situation and therefore assume the responsibility for developing, carrying out, and enforcing the safety concepts which apply to your own operation to effect the greatest safety for yourself and the people around you.

CARING FOR YOUR POWDERCOATED FINISH

The effects of ultra violet light, pollution, dirt, grime, and salt deposits accumulate on the powder coated surface of your machine over time. To extend the effective life of the powder coated surface, a regular maintenance program should be implemented for the removal of any debris or residues.

As a general rule the machine should be cleaned after every use.

- 1) Remove any loose deposits with a wet sponge
- 2) Use a soft brush (non abrasive) or cloth, & a mild household detergent solution to remove any dirt, or grime
- 3) Pressure wash or rinse when finished

Detergents that recommend the use of gloves when handling should be avoided. The detergent may be too harsh and therefore unsuitable for cleaning your powder coating. Although some strong solvents are recommended for removing grease, or other stubborn residues these may be harmful to the extended life of the powder coated surface. If paint splashes or other residue needs to be removed then use methyated spirits, turpentine or white spirits.

STORAGE

When unit is not in use, store out of the reach of children. Ensure that petrol fumes are not present in the storage area. For extensive storage periods, the fuel tank should be drained or a fuel stabiliser added. Draining the tank is strongly recommended. Engine should be stored with the intake and exhaust valves closed (compression stroke). See Engine Manual.

The screenshot shows the Red Roo Environmental Equipment website. At the top, there is a navigation bar with the company logo, contact number (1300 133 767), and social media icons. Below the navigation bar, there is a breadcrumb trail: "You are here: Home » Products » Turf Cutters". The main content area features two product listings for turf cutters: the TC350 Turf Cutter priced at \$5,445.00 and the TC400 Turf Cutter, which is currently out of stock and requires an enquiry for price. Each listing includes a "BUY ONLINE NOW" button, an "ADD TO SHORTLIST" button, and a "LEARN MORE" button. Below the product listings, there are social media sharing icons for Facebook, Pinterest, LinkedIn, Google+, and others. At the bottom of the page, there is a "WELCOME TO RED ROO" section with a brief company history, an "EXTENSIVE RANGE OF PRODUCTS" section, and a YouTube video player showing a stump grinder in use.

www.redroo.com

TC350 TURF CUTTER ILLUSTRATION 1

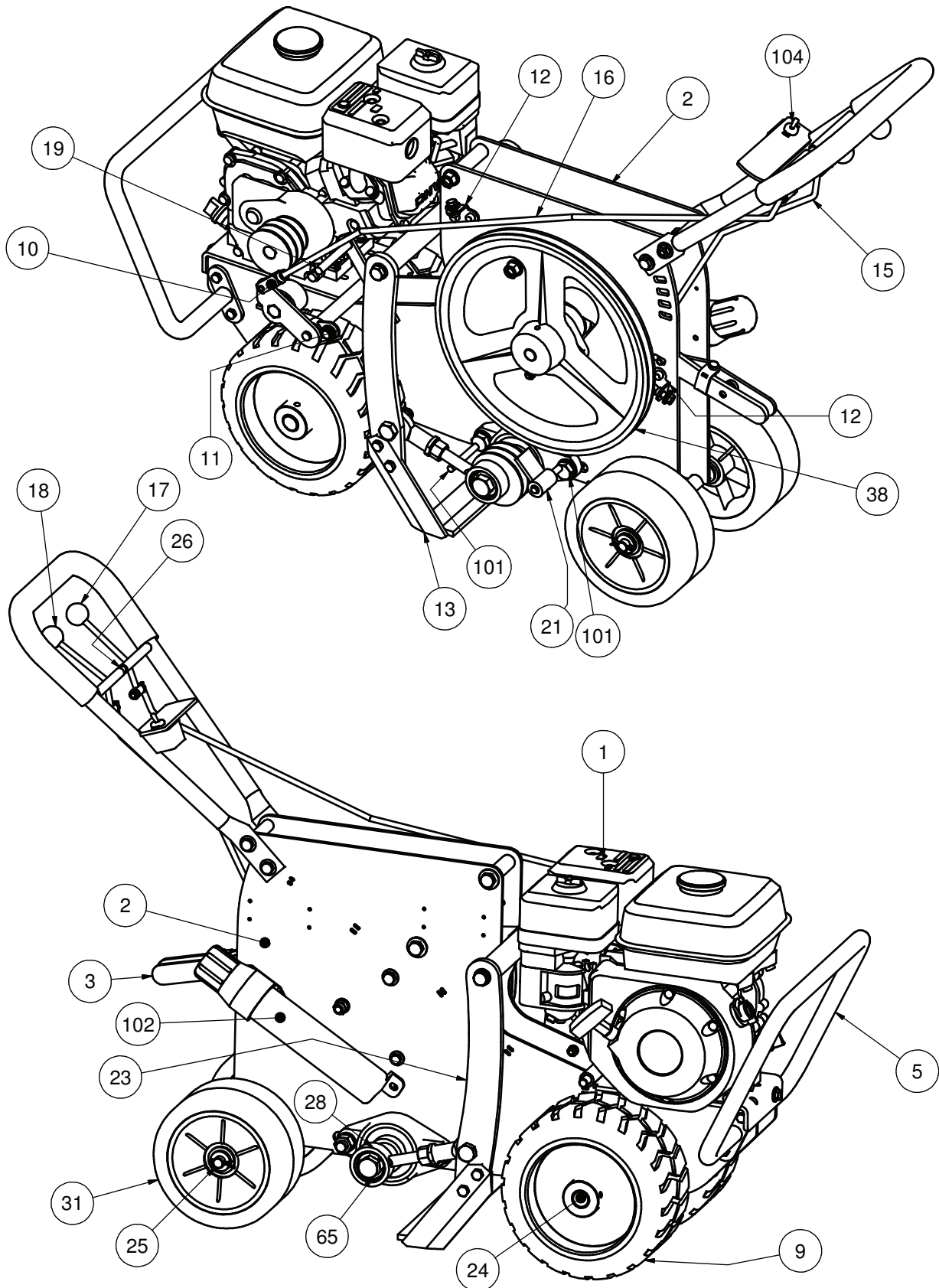

PARTS LIST FOR TC350 TURF CUTTER

Item No.	Part No.	Description	Quantity
1	0503-0007	Honda Ending	1
2	0605-0043	Main Body	1
3	0801-0027	Depth Control Handle	1
4	0202-0006	Belt Adjust - Engine Mount Bar	1
5	0704-0058	Bumper Bar	1
6	N/A	Cutter Engagement Swing Arm	1
7	N/A	Wheel Engagement Swing Arm	1
8	0801-0022	Main Handle	1
9	2305-0018	Front Wheel	2
10	2507-0007	Pull Rod Linkage - Clip	2
11	0214-0126	Belt Guard Front Mount	1
12	0214-0125	Belt Guard Bracket	2
13	0206-0023	Blade Turf Cutter	1
14	N/A	Crank Arm	2
15	1808-0031	Pull Rod Wheel Engagement - RH	1
16	1808-0032	Pull Rod Cutter Engagement - LH	1
17	0801-0024	LH Side Cutter Drive Engagement	1
18	0801-0026	RH Side Wheel Drive Engagement	1
19	0705-0013	Belt Guide Upper Cutter Drive Pulley	1
21	0705-0014	Guide Rear & Crank Pulley	1
22	0705-0011	Belt Guide - Front Wheel	1
23	0102-0017	Side Swing Arm Blade Holder	2
24	1904-0030	Front Axle	1
25	1904-0029	Rear Axle	1
26	1904-0032	Pivot Bar For Controls	1
27	1913-0028	Countershaft - Eccentric Boss	2
28	1904-0027	Countershaft	1
29	0704-0055	Guard Belt	1
30	0215-0041	Bush - Depth Control Pivot	1
31	2302-0019	Back Wheel Assy	4

safety
IS EVERYBODY'S BUSINESS
...now

You alone know the operational demands and special conditions affecting the equipment in to your situation and therefore assume the responsibility for developing, carrying out, and enforcing the safety concepts which apply to your own operation to effect the greatest safety for yourself and the people around you.

PARTS LIST FOR TC350 TURF CUTTER

Item No.	Part No.	Description	Quantity
32	1904-0025	Swing Shaft - Side Arms	1
33	1608-0041	Small Wheel Drive Pulley	1
34	1608-0040	Counter Shaft Pulley	1
35	1608-0042	Engine Pulley	1
36	1904-0031	Shaft Reduction Idler Pulley	1
38	1608-0037	Main Drive Pulley	1
39	1608-0038	Wheel Drive Pulley	1
41	0806-0033	Idler Shaft Bearing Assy	2
42	0806-0032	Front Wheel Bearing Assy	2
43	0806-0031	Crank Shaft Bearing Assy	2
57	0209-0108	Bolt	7
58	2301-0004	Washer	3
59	2301-0021	Washer	11
60	0209-0620	Bolt	4
62	2301-0013	Washer	14
63	0209-0619	Bolt	4
64	1401-0074	Nut	10
65	0209-0041	Bolt	2
66	0209-1511	Bolt	1
67	2301-0040	Washer	1
68	1401-0513	Nut	1
69	0209-0321	Bolt	4
71	1401-0033	Nut	8
72	0209-0520	Bolt	2
73	2301-0008	Washer	4
74	0209-1025	Bolt	2
75	1401-0511	Nut	3
76	2301-0507	Washer	5
78	0209-0350	Bolt	1
79	0209-0535	Bolt	2

safety
IS EVERYBODY'S BUSINESS
...now

You alone know the operational demands and special conditions affecting the equipment in to your situation and therefore assume the responsibility for developing, carrying out, and enforcing the safety concepts which apply to your own operation to effect the greatest safety for yourself and the people around you.

PARTS LIST FOR TC350 TURF CUTTER

Item No.	Part No.	Description	Quantity
82	1401-0053	Nut	2
84	1401-0023	Nut	7
85	0209-0422	Bolt	1
86	0209-0025	Bolt	2
88	2301-0007	Washer	5
90	1401-0043	Nut	3
91	0209-0142	Bolt	1
92	1401-0011	Nut	3
95	1604-0026	Pin	2
96	0209-0115	Bolt	1
97	2301-0018	Washer	13
98	1901-0804	Screw	1
100	0209-0127	Bolt	4
101	0705-0012	Belt Guide - Lower Driven Pulley	2
102	0313-0002	Document Holder	1
104	1923-0002	On - Off Toggle Switch	1

safety
IS EVERYBODY'S BUSINESS
...now

You alone know the operational demands and special conditions affecting the equipment in to your situation and therefore assume the responsibility for developing, carrying out, and enforcing the safety concepts which apply to your own operation to effect the greatest safety for yourself and the people around you.

Superseding Warranty
Red Roo Group of Companies

Warranty Policy
effective December 19th, 2017

Replaces all undated previous Warranties and all Warranties dated prior to December 19th, 2017.

“For a time period shown below from date of purchase, pending owner registration, Red Roo Sales & Service Company, P/L, herein referred to as “MANUFACTURER”, will, at its option, repair or replace for the original purchasers of new Red Roo equipment, free of charge, any part, or parts of the unit (excluding Power Unit, warranty coverage provided by respective engine manufacturer), found upon inspection and testing by a Factory Authorised Agent, or by the Factory at Keysborough, Victoria, to be defective in material or workmanship or both under normal operating conditions; this is the exclusive remedy. All transportation charges on parts submitted to the MANUFACTURER for replacement under this Warranty are the responsibility of the purchaser.

This Warranty shall not apply to any product that has been altered, modified, or operated in a manner not approved or recommended by the MANUFACTURER, Warranty will be null and void in the following circumstances: (1) repairs or attempted repairs have been performed by persons other than agents authorised by the MANUFACTURER (2) repairs are required because of normal wear; (3) the unit has been subject to abuse or involved in an accident; (4) misuse is evident, such as that caused by an application that unit is not intended to perform.

The MANUFACTURER reserves the right to modify, alter, or otherwise improve any product or part.

The purchaser is responsible for the performance of regular maintenance services as specified in the operator manual applicable to the unit. Untimely and/or improper care and replacement of normal maintenance items (eg: filters, belts, drive chains, blades, knives, lubricants) may void Warranty, Use of non genuine Red Roo parts may void Warranty.

THERE IS NO OTHER EXPRESS WARRANTY. IMPLIED WARRANTIES, INCLUDING THOSE OF MERCHANTABILITY AND FITNESS FOR A PARTICULAR PURPOSE ARE LIMITED TO 14 DAYS FROM PURCHASE, AND TO THE EXTENT PERMITTED BY LAW ANY AND ALL IMPLIED WARRANTIES ARE EXCLUDED. LIABILITY FOR CONSEQUENTIAL DAMAGES UNDER ANY AND ALL WARRANTIES ARE EXCLUDED TO THE EXTENT EXCLUSION IS PERMITTED BY LAW. RED ROO GROUP OF COMPANIES DOES NOT AUTHORISE ANY PERSON OR ENTITY TO CREATE FOR IT ANY OTHER OBLIGATION OR LIABILITY IN CONNECTION WITH ITS PRODUCTS OR SERVICES.

Some states do not allow limitations on how long an implied warranty lasts, and some states do not allow the exclusion of limitation of incidental or consequential damages, so the above limitation exclusion may not apply to you. This warranty gives you specific legal rights and you may also have other rights which vary from state to state.”

Red Roo Sales & Service Company, P/L

James A. Kerr III
Managing Director

Warranty Period

All Equipment	Consumer Use* 365 Days	Commercial Use* 90 Days
----------------------	---	--

* For the purposes of this warranty policy, “consumer use” shall mean personal residential household use by the original retail consumer. “Commercial use” shall mean all other uses, including use for commercial, income producing or hire purposes. Once a unit has experienced commercial use, it shall thereafter be considered as a commercial use unit for purposes of this warranty policy.

Proper registration of your Red Roo equipment is required to obtain warranty service. It is the responsibility of the original purchaser to register equipment within 10 days of purchase.